

## User Manual Easy UPS On-Line SRV2KRIL-IN and SRV3KRIL-IN

### Important Safety Instructions

SAVE THESE INSTRUCTIONS - This manual contains important instructions that should be followed during installation and maintenance of the Easy UPS.

Read these instructions carefully and look at the equipment to become familiar with the device before trying to install, operate, service or maintain it. The following special messages may appear throughout this manual or on the equipment to warn of potential hazards or to call attention to information that clarifies or simplifies a procedure.



The addition of either symbol to a “Danger” or “Warning” safety label indicates that an electrical hazard exists which will result in personal injury if the instructions are not followed.



This is the safety alert symbol. It is used to alert you to potential personal injury hazards. Obey all safety messages that follow this symbol to avoid possible injury or death.



### **DANGER**

**DANGER** indicates a hazardous situation which, if not avoided, **will result in death or serious injury.**



### **WARNING**

**WARNING** indicates a hazardous situation which, if not avoided, **could result in death or serious injury.**



### **CAUTION**

**CAUTION** indicates a hazardous situation which, if not avoided, **could result in minor or moderate injury.**

### **NOTICE**

**NOTICE** is used to address practices not related to physical injury.

# Product Handling Guidelines



<18 kg  
<40 lb



18-32 kg  
40-70 lb



32-55 kg  
70-120 lb



>55 kg  
>120 lb



## Safety and General Information

Inspect the package contents upon receipt. Notify the carrier and dealer if there is any damage.

### Read the Safety Guide before installing the UPS.

- This UPS is for indoor use only.
- Do not operate this UPS in direct sunlight, in contact with fluids, or where there is excessive dust or high humidity.
- Do not operate the UPS near open windows or doors.
- Be sure the air vents on the UPS are not blocked. Allow adequate space for proper ventilation.  
**NOTE:** Allow a minimum of 20 cm clearance on both front and rear sides of the UPS.
- Upto 4 External Battery Packs (Battery packs) can be connected to the Easy UPS.  
**NOTE:** For each Battery pack added, there will be an increase in the recharge time.
- Environmental factors impact battery life. Elevated ambient temperatures, poor quality utility power causing frequent discharges will shorten battery life. Follow the battery manufacturer recommendations.

### Electrical safety

- When grounding cannot be verified, disconnect the equipment from the AC Mains before installing or connecting to other equipment. Reconnect to the AC Mains only after all connections are made.
- Connection to the branch circuit (mains) must be performed by a qualified electrician.
- The protective earth conductor for the UPS carries the leakage current from the load devices (computer equipment). An insulated ground conductor is to be installed as part of the branch circuit that supplies input power to the UPS. The conductor must have the same size and insulation material as the grounded and ungrounded branch circuit supply conductors. The conductor will be green and with or without a yellow stripe.

- The grounding conductor is to be grounded to earth at the service equipment, or if supplied by a separately derived system, at the supply transformer or motor generator set.

## Battery safety

### CAUTION

#### **RISK OF HYDROGEN SULPHIDE GAS AND EXCESSIVE SMOKE**

- Replace the battery at least every 5 years or at the end of its service life, whichever is earlier.
- Replace the battery immediately when the UPS indicates battery replacement is necessary.
- Replace batteries with the same number and type of batteries as originally installed in the equipment.
- Replace the battery immediately when the UPS indicates a battery over-temperature condition, or when there is evidence of electrolyte leakage. Power off the UPS, unplug it from the AC input, and disconnect the batteries. Do not operate the UPS until the batteries have been replaced.
- \*Replace all Battery packs which are older than one year, when installing additional battery packs.

**Failure to follow these instructions can result in minor or moderate injury and equipment damage.**

\* Contact APC by Schneider Electric Customer Support to determine the age of the installed battery modules.

- APC by Schneider Electric uses Sealed Maintenance-Free Valve Regulated Lead Acid (SMF) batteries. Under normal use and handling, there is no contact with the internal components of the batteries. Over charging, over heating or other misuse of batteries can result in leakage of battery electrolyte. Released electrolyte is toxic and may be harmful to the skin and eyes.
- Use tool with insulated handles.
- Wear rubber gloves and boots.
- Determine if battery is either intentionally or inadvertently grounded. Contact with any part of a grounded battery can result in electric shock or burns by high short-circuit current. The risk of such hazards can be reduced if grounds are removed during installation and maintenance by a skilled person.
- CAUTION: Before installing or replacing the batteries, remove jewelry such as wristwatches and rings.

High short circuit current through conductive materials could cause severe burns.

- CAUTION: Do not dispose of batteries in a fire. The batteries may explode.
- CAUTION: Do not open or mutilate batteries. Released material is harmful to the skin and eyes and may be toxic.

## Radio Frequency Warning









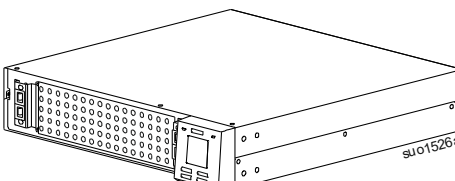

This UPS is a category C2 product as per IEC 62040-2. In a residential environment, this product may cause radio interference, in which case the user may be required to take additional measures.

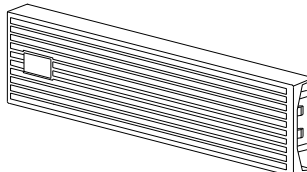
## Product Description

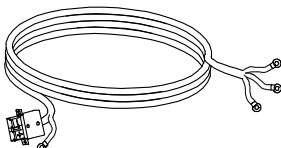
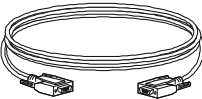
The APC by Schneider Electric Easy UPS is a high performance, uninterruptible power supply (UPS). The Easy UPS helps to provide protection to electronic equipment from utility power blackouts, brownouts, sags, surges, small utility fluctuations and large disturbances. The Easy UPS also provides battery backup power to connected equipment until utility power returns to normal levels or the batteries are fully discharged.

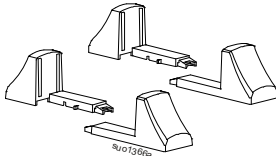
This user manual is available on the APC by Schneider Electric Web site, [www.apc.com](http://www.apc.com).

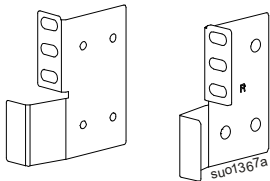
# Package Contents

<p>Easy UPS</p>  <p>A line drawing of a rack-mountable Easy UPS unit, model SU01520A, showing the front panel with various ports and a display screen.</p>	<p>PowerChute software download guide</p>  <p>A screenshot of the PowerChute software download guide, featuring a green border and text including 'Dear Customer', 'Congratulations on your Easy UPS purchase', and 'NOTES'.</p>	
<p>Front bezel</p>  <p>A line drawing of a long, narrow front bezel with a central slot and ventilation slats.</p>	<p>USB cable</p>  <p>A line drawing of a standard USB-A to USB-B cable.</p>	
<p>Battery cable</p>  <p>A line drawing of a battery cable with a connector on one end and three wires on the other.</p>	<p>Serial communication cable</p>  <p>A line drawing of a serial communication cable with two DB-9 connectors.</p>	
<p>User documentation</p>  <p>A line drawing of the user documentation manual, showing the title page with the APC logo and 'Overview' text.</p>	<p>Stabilizer brackets x2 pairs</p>  <p>Foot stand screws x4</p>  <p>Line drawings of two pairs of stabilizer brackets and four foot stand screws. One bracket is labeled SU01365B.</p>	<p>Rack-mount bracket x1 pair</p>  <p>Flat head screws x8</p>  <p>Line drawings of one pair of rack-mount brackets and eight flat head screws. One bracket is labeled SU01367A.</p>

**NOTE:**

The model and serial numbers are located on a label in the top panel.  
 The packaging is recyclable; save it for reuse or dispose of it properly.  
 For package contents of Battery pack, refer to the installation manual supplied along with Battery pack.

# Optional Accessories

Refer to the APC by Schneider Electric Web site, [www.apc.com](http://www.apc.com), for available accessories.

## Specifications

### Environmental specifications

#### NOTICE

##### RISK OF EQUIPMENT DAMAGE

- UPS must be used indoors only.
- The installation location should be sturdy to withstand the weight of the UPS.
- Do not operate UPS where there is excessive dust or where the temperature or humidity are outside specified limits.

**Failure to follow these instructions can result in equipment damage.**

Temperature	Operating	0 to 40 °C at rated load 40 to 50 °C linearly derated to 80% of maximum load capacity
	Storage	-20 to 60 °C
Elevation	Operating	0 to 2,000 m: normal operation 2,000 to 3,000 m: The output power reduces @ 1% for increase in height of every 100 m >3,000 m: UPS will not work
	Storage	0 to 15,000 m
Humidity		0 to 95% relative humidity, non-condensing
International Protection Code		IP20

**NOTE:** Charge the battery module at least once in every six months during storage.

## Physical specifications

UPS		SRV2KRIL-IN	SRV3KRIL-IN
Power Module		SRVPM2KRIL-IN	SRVPM3KRIL-IN
Battery Pack		SRV72RBP-9A	
Dimensions with package Width x Height x Depth	Power Module	545 mm x 240 mm x 700 mm (21.5 in x 9.5 in x 27.56 in)	
	Battery Pack	600 x 240 x 800 mm (23.6 x 9.45 x 31.5 in)	
Dimensions without package Width x Height x Depth	Power Module	438 mm x 86 mm x 462 mm (17.2 in x 3.4 in x 18.2 in)	
	Battery Pack	438 x 86 x 632 mm (17.2 x 3.4 x 24.9 in)	
Weight with package (approx.)	Power Module	13 kg	13.7 kg
	Battery Pack	45 kg	
Weight without package (approx.)	Power Module	9.3 kg	10.1 kg
	Battery Pack	40 kg	

## Dimensions D1 and D2

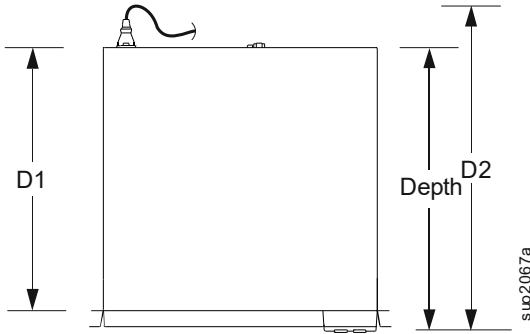

D1 Dimension	D2 Dimension	Depth
430 mm (16.9 in)	522 mm (20.6 in)	462.28 mm (18.2 in)

## Input/Output specifications

		SRVPM2KRIL-IN	SRVPM3KRIL-IN
<b>Input</b>	Nominal input voltage	230 VAC	
	Input frequency	40 - 70 Hz	
	Input voltage range (100% load)	160 to 280 VAC at < 35 °C	
	Input voltage range at (50% load)	110 to 280 VAC	
	Input power factor (100% resistive load at nominal input voltage)	≥ 0.95 in online mode	
	Input protection	Thermal circuit breaker	
<b>Output</b>	UPS Capacity	2000 VA / 1600 W	3000 VA / 2400 W
	Nominal output voltage	230 VAC	
	Other programmable voltage	220 VAC, 240 VAC	
	Efficiency at rated load at 230V input and resistive load	88%	90%
	Output voltage regulation	±1% static	
	Output voltage distortion	<ul style="list-style-type: none"> <li>• 3% max. for full linear load</li> <li>• 6% max. for full non linear load (100% VA, 0.8 PF)</li> <li>• 15% for the last 60 seconds of the backup time</li> </ul>	
	Frequency - On battery	50 Hz ± 0.5% or 60 Hz ± 0.5%	
	Frequency - AC mode	50 ± 3 Hz or 60 ± 3 Hz	
	Crest factor	3:1	
	Waveform	Sinewave	
	Output connection	Refer to “Rear Panel Features” on page 16 for details.	
	Bypass	Internal Lower setting: 161/173/184/196 VAC Upper setting: 242/253/265/276 VAC	



## Battery

<b>UPS Model</b>	<b>SRV2KRIL-IN</b>	<b>SRV3KRIL-IN</b>
<b>Power Module</b>	SRVPM2KRIL-IN	SRVPM3KRIL-IN
<b>Battery Pack Model</b>	SRV72RBP-9A	
<b>Configuration</b>	External battery	
<b>Type</b>	Sealed maintenance free (SMF) valve regulated lead acid battery, 12 V, 9 Ah	
<b>Battery Bank Voltage</b>	72 VDC	
<b>Typical Capacity</b>	1296 Wh	
<b>Recommended Charge Voltage</b>	81.6 VDC	
<b>Maximum Battery Pack Support</b>	4	

\* XLBP Cable Length - 600m (23.6 in)

## Tower Installation

### CAUTION

#### RISK OF FALLING EQUIPMENT

- The Easy UPS is heavy.
- Always practice safe lifting techniques adequate for the weight of the equipment.
- Do not lift the Easy UPS by holding the front panel display.
- Ensure that the stabilizer brackets are installed along with the Easy UPS in tower orientation.

**Failure to follow these instructions can result in minor or moderate injury and equipment damage.**

#### Front panel display rotation

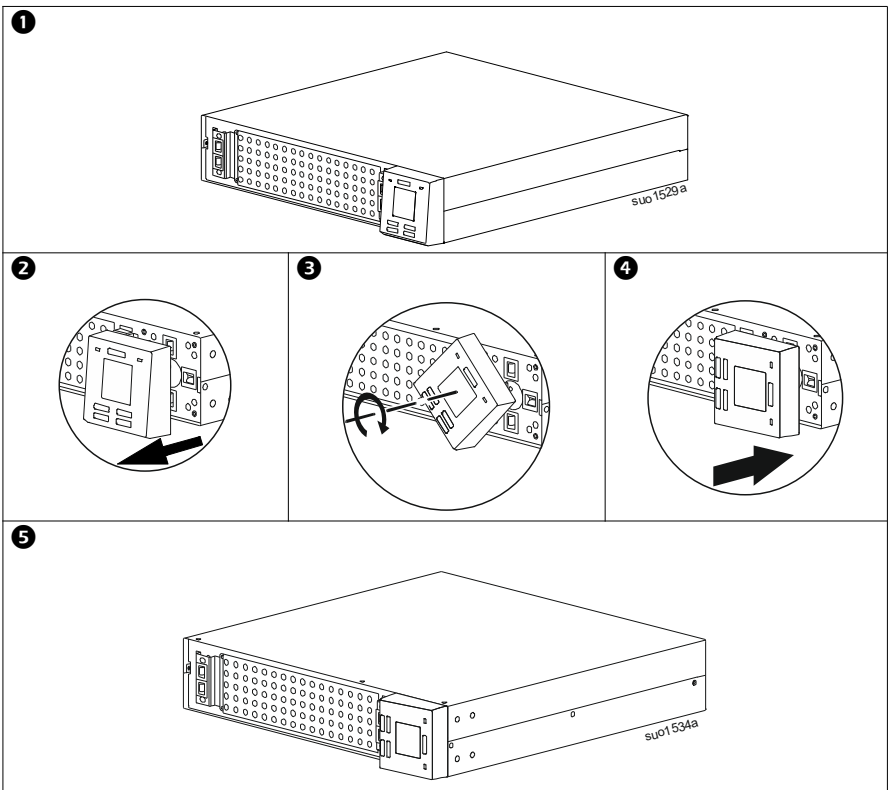

## Installing stabilizer brackets

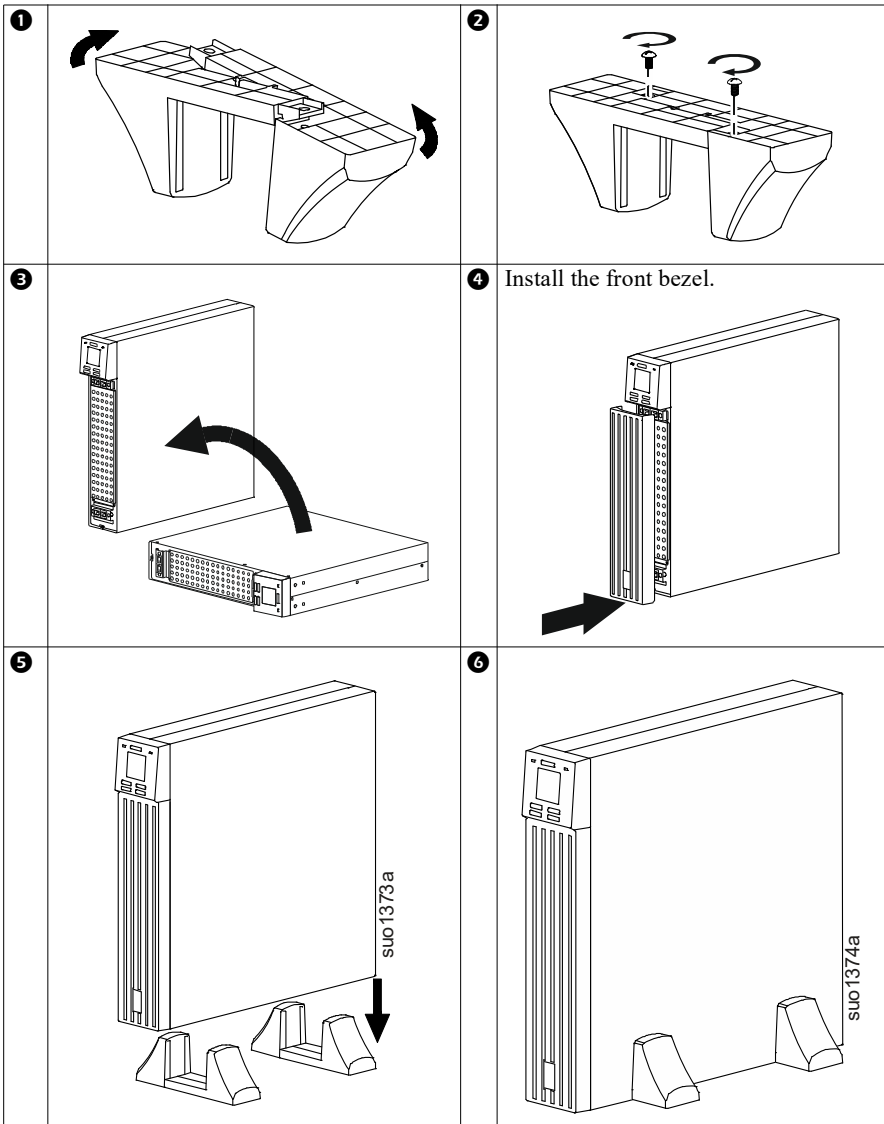

**NOTE:** Maintain approximately 70 mm distance from the edge of the unit, when installing the stabilizer brackets to the Easy UPS.

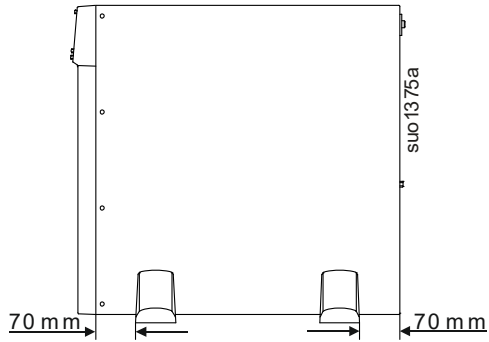

# Rack-Mount Installation

## CAUTION

### RISK OF FALLING EQUIPMENT

- The Easy UPS is heavy.
- Always practice safe lifting techniques adequate for the weight of the equipment.
- Do not lift the Easy UPS by holding the front panel display.
- Always install the UPS at the bottom of the rack.
- Always use the recommended number of screws to secure brackets to the UPS.
- Given the heavy weight, the use of rack-mount brackets is mandatory during rack installation (guide with L-shaped support).
- Secure the unit to the rack using all the screws supplied for the purpose.

**Failure to follow these instructions can result in minor or moderate injury**

Optional Rail Kit accessories SRVRK1 to enable the installation of Easy UPS in rack-mount configuration and SRVRK2 to enable the installation of the battery pack, are available for purchase.

### NOTE:

Install the UPS above the Battery pack.

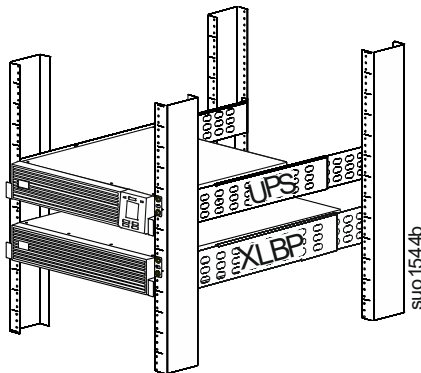

For instructions to install Battery pack in rack-mount configuration, refer to the installation manual supplied along with Battery pack.

- 1 Install the rack-mount brackets.

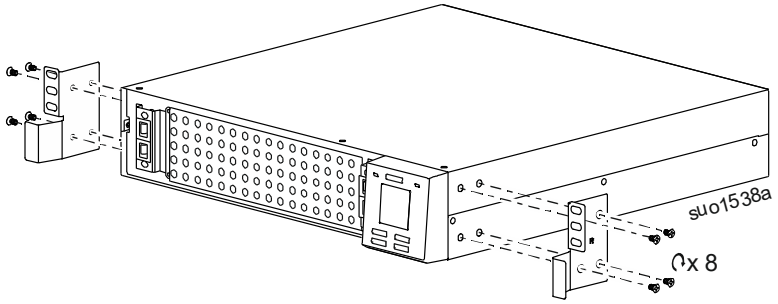

- 2 Lift the Easy UPS module and slide it into rack enclosure.

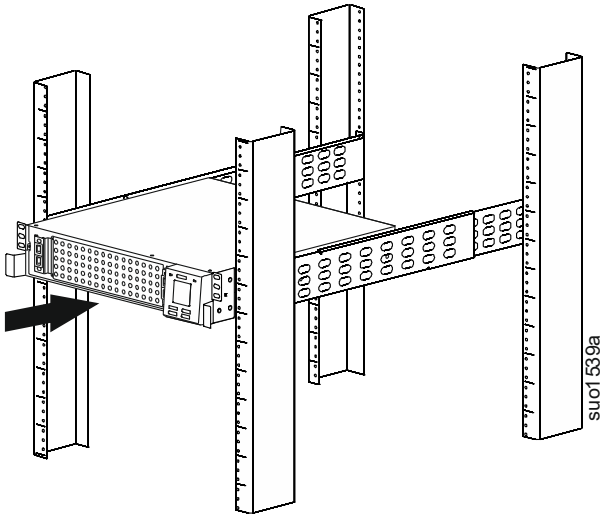

- 3 Secure the Easy UPS module to the rack with screws, nuts and washers (not supplied).

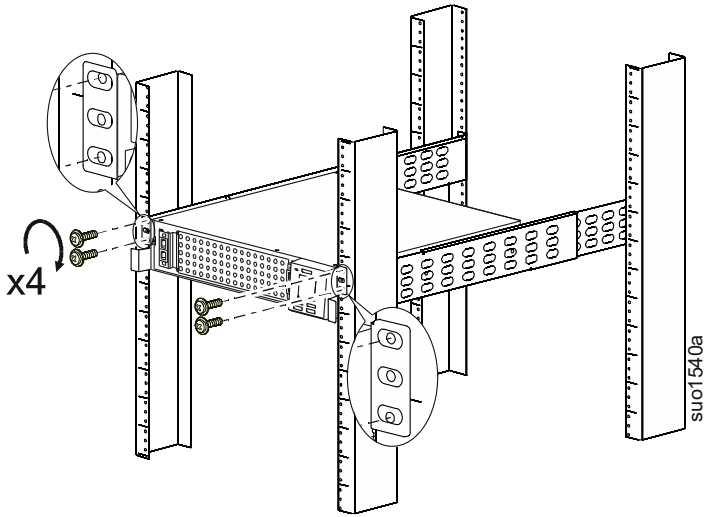

- 4 Install the front bezel.

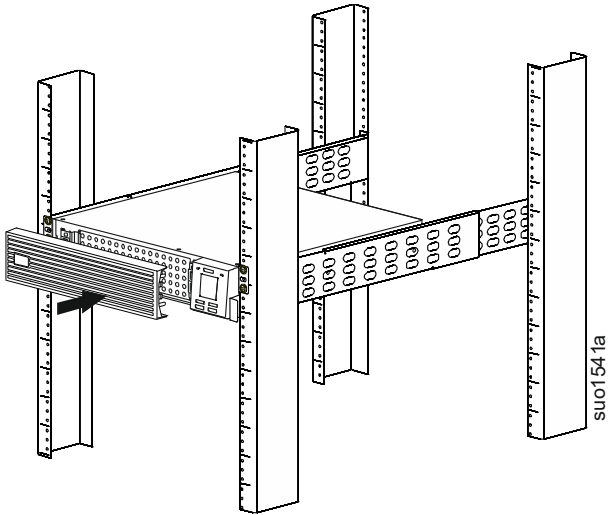

# Rear Panel Features

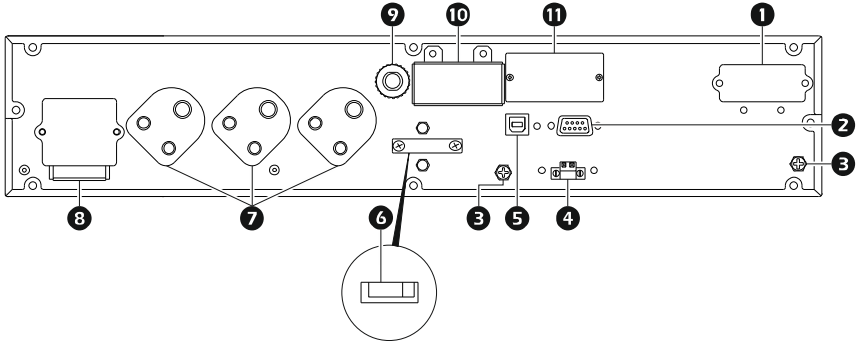

Actual UPS may differ in appearance from the illustration.

<b>1</b>	Battery connector
<b>2</b>	Serial communication connector
<b>3</b>	Ground screw
<b>4</b>	Emergency power off (EPO) connector
<b>5</b>	USB port
<b>6</b>	Charger current selector switch
<b>7</b>	6 A battery backup outlets
<b>8</b>	16 A battery backup output hardwire terminal block
<b>9</b>	Input circuit breaker
<b>10</b>	Input hardwire terminal block
<b>11</b>	Intelligent slot for management accessories



# Hardwiring

## CAUTION

### RISK OF ELECTRIC SHOCK

- Adhere to all national and local electrical codes.
- All electrical work must be performed by a qualified electrician.
- Turn off all power to this equipment before working on the equipment.
- Switch the external circuit breaker off. Practice lockout/tagout procedures.
- Do not wear jewelry when working with electrical equipment.
- Select wire size and connectors according to national and local codes.

**Failure to follow these instructions can result in moderate injury.**

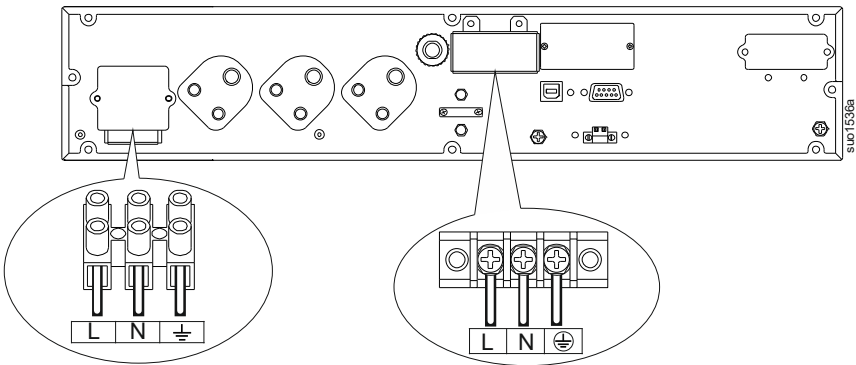

### Input hardwiring

- Use 12 AWG (4 mm<sup>2</sup>) wire (not supplied) for hardwiring the input.
1. Locate the cover of the input hardwire terminal block on the rear panel.
  2. Remove the screws securing the cover and remove the cover.
  3. Connect the line, neutral and earth/ground wires to the terminal block. Terminals are labeled for proper wire configuration.
  4. Replace and secure the cover using the screws removed in *step 2*.

## Output hardwiring

- Use 12 AWG (4 mm<sup>2</sup>) wire (not supplied) for hardwiring the output.
1. Locate the cover of the 16 A output hardwire terminal block on the rear panel.
  2. Remove the screws securing the cover and remove the cover.
  3. Connect the line, neutral and ground wires to the terminal block. Terminals are labeled for proper wire configuration.
  4. Replace and secure the cover using the screws removed in *step 2*.

# Connect the Battery Pack

## CAUTION

### RISK OF ELECTRIC SHOCK

- Adhere to all national and local electrical codes.
- All electrical work must be performed by a qualified electrician.
- Identify the polarities of the battery terminals before connecting the battery. Be sure ground wire (green color wire) is connected firmly.
- Do not short the battery terminals.
- Do not wear jewelry when working with electrical equipment.

**Failure to follow these instructions can result in moderate injury.**

## NOTICE

### RISK OF IMPROPER CONNECTION

Connect the battery according to the battery voltage indicated on the rear panel. If the connected battery voltage is incorrect, UPS may be damaged and cannot be repaired. Therefore, be sure that the battery voltage is in accordance with the UPS specification.

**Failure to follow these instructions can result in equipment damage.**

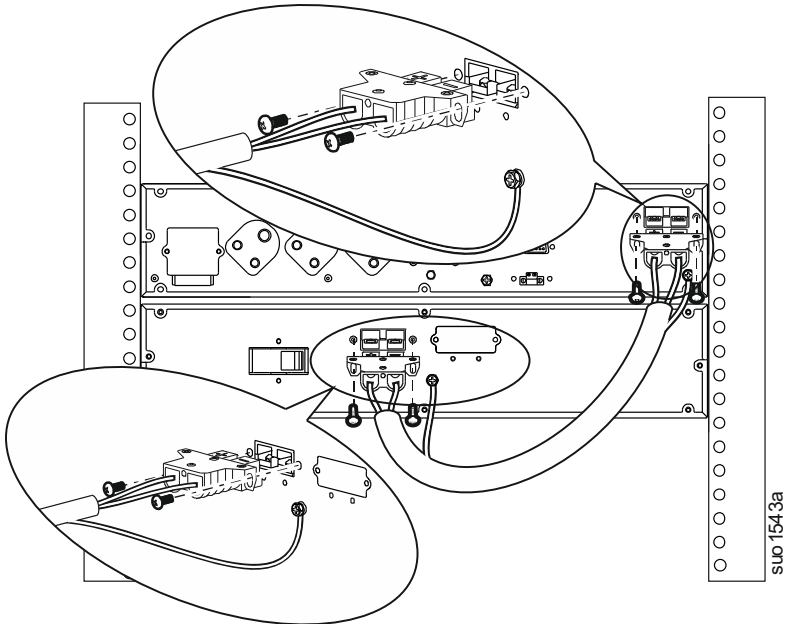

1. Locate the battery connector cover on rear panel of Easy UPS and Battery pack. Remove the screws securing the cover and remove the cover.
2. Use the battery connection cable supplied with the Battery pack.
3. Plug one end of the external battery cable connector into the battery connector receptacle on the rear side of the Easy UPS and the other end of the external battery cable connector into the battery connector receptacle on the rear side of the Battery pack.
4. Insert the screws removed in *step 1* and tighten the screws to secure the external battery connector receptacle to the battery connector on the rear panel of Easy UPS and Battery pack.
5. Connect the ground wire to the ground terminal in the Easy UPS and Battery pack.

## Start Up

### Connect equipment and input power to the Easy UPS



#### CAUTION

##### HAZARD OF ELECTRIC SHOCK

- All electrical work must be performed by a qualified electrician.
- Turn off all power to this equipment before working on the equipment. Practice lockout/tagout procedures.
- Do not wear jewelry when working with electrical equipment.

**Failure to follow these instructions can result in moderate injury.**

1. Connect equipment either to the 6 A outlets or to the 16 A hardwire terminal block. For connecting equipment to the 16 A hardwire terminal block refer “Output hardwiring” on page 18 for details.
2. Connect Battery pack to the Easy UPS. Refer “Connect the Battery Pack” on page 19 for details.
3. Set the charger current for the number of Battery packs connected to the Easy UPS. Refer “Charger current selection” on page 28 for details.
4. Connect input utility power to the Easy UPS. Refer to “Input hardwiring” on page 17 for details.
5. Turn on the circuit breaker of the Battery pack.
6. Switch on the input utility power. The Easy UPS display panel will illuminate.

## Start the Easy UPS

Press the POWER ON/OFF button located on the front panel of Easy UPS. The Status LED will illuminate green.

- The battery charges to 90% capacity during the first five hours of normal operation.
- **Do not** expect full backup time during this initial charge period.

## Cold start the Easy UPS

Use cold start feature to supply power to connected equipment from the Easy UPS batteries.

Press the POWER ON/OFF button. The display panel will illuminate.

Press the POWER ON/OFF button again to supply battery power to the connected equipment.

## Turn off the Easy UPS

To turn off the Easy UPS, press and hold the POWER ON/OFF button on the front panel display until a beep is heard.

## Connect and install management software

Easy UPS SRV models are provided with PowerChute™ management software for unattended operating system shutdown, UPS monitoring, UPS control and energy reporting.

1. Connect the USB cable from the rear of the UPS to the protected device such as a server.

**NOTE:** A USB driver is required to communicate with PowerChute over USB. For more information, refer to Knowledge Base article FAQ000223363 on the APC by Schneider Electric website (<https://www.apc.com/us/en/faqs/home>).

2. For a server or other device with an operating system, download and install the latest version of the PowerChute Serial Shutdown from [www.apc.com/pcss](http://www.apc.com/pcss). PowerChute Serial Shutdown supports graceful shutdown in the event of an extended power outage.

**NOTE:** PowerChute is a 64-bit application and cannot be installed on a 32-bit operating system

3. A built-in serial port is also available for additional communication options with serial cable.

**NOTE:** Both RS232 Serial Port and USB Communication Port cannot be used at the same time.

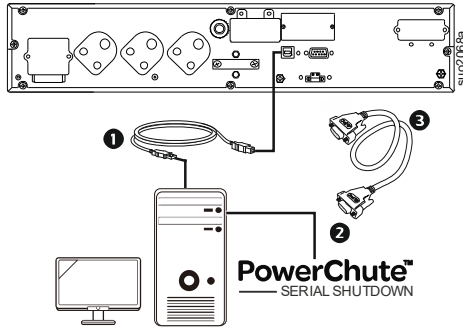

❶	Connect the USB cable from the rear of the Easy UPS to the computer.
❷	Download and install the latest version of PowerChute Serial Shutdown from <a href="https://www.apc.com/pcss">https://www.apc.com/pcss</a> .
❸	A built-in serial port is also available for additional communication options with serial cable.

Additional communication options are available via the built-in intelligent card slot. Refer to the APC by Schneider Electric Web site, [www.apc.com](http://www.apc.com), for more information.

# Emergency Power Off

## NOTICE

### RISK OF EQUIPMENT DAMAGE

- Do not connect the EPO interface to any circuit other than an unused circuit.
- Adhere to all national and local electrical codes.
- Wiring must be performed by a qualified electrician.

**Failure to follow these instructions can result in equipment damage.**

The Emergency Power Off (EPO) function is a feature that will immediately remove power to all connected equipment. When EPO button is pressed, all connected equipment will immediately turn off.

The EPO switch is internally powered by the Easy UPS for use with non-powered switches or potential free normally closed (N/C) contacts.

### Connecting normally closed (N/C) contacts

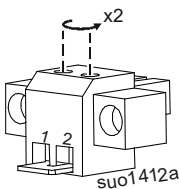
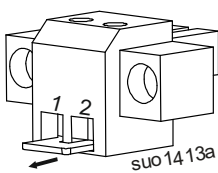
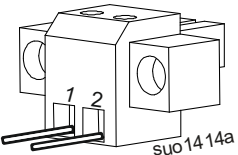
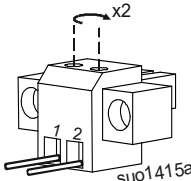
<p><b>1</b> Loosen the screws of terminals 1 and 2 in the EPO connector.</p> 	<p><b>2</b> Remove the metal link between pins 1 and 2.</p> 
<p><b>3</b> Connect N/C relay contacts between pins 1 and 2 of the EPO terminal block. Use 0.5 to 1 mm<sup>2</sup> wire.</p> 	<p><b>4</b> Secure the EPO connector screws beneath pins 1 and 2.</p> 

**NOTE:** If the N/C is open, the Easy UPS will turn off and power will be removed from the load.

**The EPO interface is a Safety Extra Low Voltage (SELV) circuit. Connect it only to other SELV circuits. The EPO interface monitors circuits that have no determined voltage potential. Such closure circuits may be provided by a switch or relay properly isolated from the utility. To avoid damage to the Easy UPS, do not connect the EPO interface to any circuit other than an unused circuit.**

Use one of the following cable types to connect the Easy UPS to the EPO switch.

- CL2: Class 2 cable for general use.
- CL2P: Plenum cable for use in ducts, plenum, and other spaces used for environmental air.
- CL2R: Riser cable for use in a vertical run in a floor-to-floor shaft.



# Operation





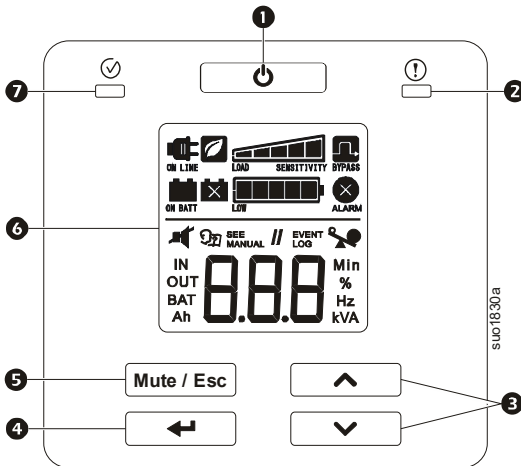





## Front panel display features

Easy UPS models are equipped with an intuitive and configurable LCD display. The display complements the software interface as they convey similar information and either may be used to configure the Easy UPS settings.



<b>1</b>	<b>POWER ON/OFF button</b>	Press the POWER ON/OFF button to turn the Easy UPS on. Press and hold the POWER ON/OFF button until a beep is heard to turn the Easy UPS off. Press the POWER ON/OFF button to reset alerts.
<b>2</b>	<b>Alert LED</b>	The <b>Alert</b> LED illuminates red when the Easy UPS detects an internal error and blinks red for Easy UPS notifications. Refer “Alerts and Notifications” on page 34 for details.
<b>3</b>	<b>UP/DOWN ARROW button</b>	Press the UP/DOWN ARROW button to scroll through the main menu options and display screens.
<b>4</b>	<b>ENTER button</b>	Press the ENTER button to enter the menu or to select a menu item/value during navigation.
<b>5</b>	<b>MUTE/ESC button</b>	Press the MUTE/ESC button: <ul style="list-style-type: none"> <li>• To acknowledge audible alerts and suppress them temporarily.</li> <li>• To exit a sub menu and return to the main menu.</li> </ul>
<b>6</b>	<b>LCD Display</b>	The display interface options are visible on this LCD screen. Press any button to activate LCD, if the display is not illuminated.
<b>7</b>	<b>Status LED</b>	The <b>Status</b> LED illuminates green when the power is on. The LED indicates two different states of output power: <ul style="list-style-type: none"> <li>• <b>Output off:</b> LED blinks on and off. Press POWER ON/OFF button to turn the output power on.</li> <li>• <b>Output on:</b> LED illuminates green continuously.</li> </ul>

## Front panel display icons

 <p>ON LINE</p>	<p><b>On Line:</b> The Easy UPS is drawing utility power and performing double conversion to supply power to the connected equipment.</p>
 <p>ON BATT</p>	<p><b>On Battery:</b> The Easy UPS is supplying battery backup power to the connected equipment.</p>
	<p><b>Replace Battery:</b> The battery is not connected securely or the battery is nearing the end of its service life and should be replaced.</p>
 <p>BYPASS</p>	<p><b>Bypass:</b> The Easy UPS is in bypass mode, sending utility power directly to connected equipment. Bypass mode operation is the result of an internal UPS event, an overload condition, or a user initiated command either through the display interface or through an accessory. Battery operation is not available while the Easy UPS is in bypass mode. Refer “Alerts and Notifications” on page 34 for details.</p>
 <p>ALARM</p>	<p><b>System Alerts:</b> An internal error is detected. Refer “Alerts and Notifications” on page 34 for details.</p>
	<p><b>Overload:</b> The equipment connected to the Easy UPS is drawing more power than rated.</p>
	<p><b>Battery Charge:</b> The battery charge level is indicated by the number of bar sections illuminated. When all five blocks are illuminated, the battery is fully charged. Each bar represents approximately 20% of the battery charge capacity.</p>
	<p><b>Load Level:</b> The load percentage is indicated by the number of load bar sections illuminated. Each bar represents approximately 20% of the load.</p>
	<p><b>Mute:</b> An illuminated line through the icon indicates that the audible alert is disabled.</p>
	<p><b>Green Mode:</b> An illuminated icon indicates that the unit is working in Green mode. The connected equipment is receiving the utility input directly as long as the input voltage and frequency are within the configured limits.</p>
 <p>SEE MANUAL</p>	<p><b>Alert or notification:</b> The Easy UPS has detected an internal error or the Easy UPS is in configuration mode. Refer “Alerts and Notifications” on page 34 for details.</p>
<p>EVENT LOG</p>	<p><b>Event:</b> The icon is illuminated when the user is viewing the event log.</p>

## Status Indicators

Audible Alert	Condition
Continuous beeps, every half second	<b>Low Battery State</b> - The battery is nearing its discharge state. The Easy UPS is about to shutdown. <b>Overload condition</b> - The equipment connected to the Easy UPS is drawing more power than rated.
4 beeps every 30 sec (first beep starts after 4 sec on battery)	<b>On Battery State</b> - The Easy UPS is supplying battery backup power to the connected equipment.
Beeper continuously on	<b>Alert State</b> - Easy UPS has detected an internal error. Refer “Alerts and Notifications” on page 34 for details.
Short beep every 2.5 sec	Battery disconnected.
Continuous short beeps for every half second for 1 minute, repeats every 5 hours	Bad battery (replace).
Two short beeps every 5 sec	<b>Event Bypass State</b> - Easy UPS has detected an internal error. Connected equipment receives utility input power through the bypass relay.

## Easy UPS Display Parameters

Operational data displayed in the display panel is given in the table.

Navigate using the UP/DOWN ARROW buttons.

Parameter	Units	Indicator Icons
<b>Output voltage</b>	VAC	OUT, V
<b>Output frequency</b>	Hz	OUT, Hz
<b>Input voltage</b>	VAC	IN, V
<b>Input frequency</b>	Hz	IN, Hz
<b>State of battery charge</b>	%	BAT,%
<b>Battery voltage</b>	VDC	BAT, V
<b>Ambient temperature</b>	°C	NUMBER, C
<b>Remaining On Battery runtime</b>	Minutes	BAT, Min
<b>Load level in percentage (Maximum of Watts or VA)</b>	%	OUT,%
<b>Load level in kVA</b>	kVA	OUT, kVA
<b>Total Ah capacity of connected battery</b>	Ah	BAT, Ah

# Configuration

## Charger current selection

1. Locate the cover of the charging current selector switch on the rear panel.
2. Remove the screws securing the cover and remove the cover.
3. Set the charger current through the selector switch.
4. Replace and secure the cover removed in *step 2*.

### **WARNING**

#### **RISK OF FIRE**

Select the correct Charger Current for the number of Battery packs connected to the Easy UPS.

**Failure to follow this instruction can result in death or serious injury.**

<b>Number of battery packs connected to Easy UPS</b>	1	2	3	4
<b>Charger current setting</b>	2 A	3 A	4 A	4 A

## Easy UPS settings

Configure Easy UPS settings using the front panel display interface. Refer “Configure Easy UPS parameters” on page 31 to edit the parameters.





Function	Factory Default	User Selectable Options	Description
<b>Output voltage</b>	230 VAC	220, 230, 240 VAC	Allows the user to select output voltage while the Easy UPS is in standby mode.
<b>Audible alert</b>	☑ (Enable)	☑ (Enable) ☐ (Disable)	Easy UPS will mute audible alerts when set to <b>disable</b> or when the front panel display buttons are pressed.
<b>Green mode/ high efficiency mode</b>	☐ (Disable)	☑ (Enable) ☐ (Disable)	When this mode is enabled, connected equipment receives utility input power through the bypass relay as long as input voltage is within the range of $\pm 5\%$ of configured output voltage and $\pm 3$ Hz of configured output frequency. Inverter is turned off during this mode. If utility power input goes out of range, inverter is turned on and the load is transferred to online mode or battery mode. The power to the connected equipment may be interrupted up to 10 milliseconds.

<b>Function</b>	<b>Factory Default</b>	<b>User Selectable Options</b>	<b>Description</b>
<b>Battery Ah capacity</b>	9 Ah	7 to 72 Ah	Allows the user to set the Total Ah of the batteries connected to the Easy UPS. Capacity of each Battery pack is 9 Ah. Add the battery capacity (Ah) of all the connected Battery packs and set this value as the Total Battery Ah capacity.
<b>Minimum battery capacity to restart setting</b>	0%	0%, 15%, 50%, 90%	Easy UPS output will not be turned on until the battery is charged to a level such that it can provide the runtime configured by this setting. If configured to 0%, Easy UPS output is turned on immediately after utility power returns.
<b>Low battery state indication setting</b>	2 min	2 min, 5 min, 7 min, 10 min	The Easy UPS will emit an audible alarm when the remaining run time reaches the limit set by the user when the Easy UPS is in battery mode. Audible alarm will continue in online mode till the run time of the Easy UPS reaches the set limit.
<b>Bypass setting</b> <b>Lower voltage</b> <b>Upper voltage</b>	184 VAC 276 VAC	161, 173, 196 VAC 253, 242, 265 VAC	Allows the user to set the upper and lower voltage settings for Bypass.

# Advanced display navigation

The Easy UPS display has five menu options. Press the ENTER button from the Home Screen to access these menu options. Use the UP/DOWN ARROW buttons to navigate between the menu options.

Menu option	Description
LOG	<p><b>Show Event Log</b>            Use this menu option to see the Easy UPS event log. The Easy UPS records the last 10 events and displays the codes in this log.            Press the ENTER button to see the log. Use the UP/DOWN ARROW buttons to see the logged events. The UP ARROW button navigates towards old events and the DOWN ARROW button navigates to new events.            Every log entry has a numeric and textual event code.            At the end of the log, the word “End” will be displayed.            Press the MUTE/ESC button to return to the Home Screen.</p>
SET	<p><b>Configure the Easy UPS</b>            Use this menu option to configure the Easy UPS parameters.            Press the ENTER button to see the configuration options.            Refer “Configure Easy UPS parameters” on page 31 for details.            Press the MUTE/ESC button to return to the Home Screen.</p>
UPS	<p><b>Show Easy UPS information</b>            Use this menu option to see the Easy UPS information.            Press the ENTER button to see the rating of the Easy UPS.            Press the UP ARROW button to see the Easy UPS firmware version.            Press the MUTE/ESC button to return to the Home Screen.</p>
byp	<p><b>User Command to bypass</b>            Use this menu option to switch the Easy UPS to bypass mode or bring the Easy UPS to online mode from bypass mode.            Press ENTER button:</p> <p><b>Put</b>      <b>Put:</b> Use to switch the Easy UPS to bypass mode of operation. The Easy UPS will start a count down on the display.  <b>NOTE:</b> Power to the connected equipment will drop, if the mains voltage is not within the threshold limits.</p> <p><b>Out</b>      <b>Out:</b> Bring the Easy UPS out of bypass and restore clean power to the connected equipment.</p> <p>The Easy UPS will start a count down on the display while switching to Bypass mode or coming out of Bypass mode.</p>

Menu option	Description
	<p><b>Execute Battery Self Test</b>            Use this menu option to conduct a self test and determine the battery status. Press the ENTER button to initiate the test. If the test command is accepted, the Easy UPS will initiate a self test and will start a count down on the display. Display messages are shown at the end of the test.</p> <p> Test refused. The output is off or battery is not charged or battery is disconnected.</p> <p> Test not passed.</p> <p> Test passed.</p> <p> Test is aborted due to internal reasons.</p> <p>Press the MUTE/ESC button to return to the Home Screen.</p>

### Configure Easy UPS parameters

Follow the steps to configure parameters in the Easy UPS:

1. Press the ENTER button.
2. Press the UP/DOWN ARROW buttons to navigate to “Set”.
3. Press the ENTER button.
4. Navigate through the parameters using the UP/DOWN ARROW buttons.
5. Press the ENTER button to edit a parameter. Icons start flashing to indicate the editing.
6. Press the UP/DOWN ARROW buttons to navigate between the options available for the selected parameter.
7. Press the ENTER button to select the option or MUTE/ESC button to abort the editing of current parameter. Flashing of icons stops after this.
8. Press the UP/DOWN ARROW buttons to navigate between parameters.
9. Press the MUTE/ESC button to exit menu navigation.

# Troubleshooting

Use the table below to solve minor installation and operation problems. Refer to the APC by Schneider Electric Web site, [www.apc.com](http://www.apc.com) for assistance to complex Easy UPS problems.

Problem and/or Possible Cause	Solution
<b>Easy UPS will not turn ON when utility input is available or there is no power output</b>	
The Easy UPS is not turned on.	Press the POWER button to turn on the Easy UPS.
The Easy UPS is not connected to utility power supply.	Be sure that the power cable from the Easy UPS to the utility power supply is securely connected at both ends.
Input thermal circuit breaker on the Easy UPS is tripped.	Press the input thermal circuit breaker RESET button in the rear panel.
<b>The Easy UPS is operating on battery, while connected to the input utility power</b>	
Input voltage and frequency are beyond specifications.	Connect the Easy UPS to a different outlet on a different circuit. Test the utility input power to ensure the unit is receiving input power. If display is on, navigate and check the input voltage and frequency.
<b>Easy UPS, when connected to Battery pack, is not supplying power to the connected equipment</b>	
The Easy UPS is not turned on.	If the Easy UPS has shutdown (the display is not on), follow the “Cold start the Easy UPS” on page 21 procedure.
The Battery pack is not connected.	Connect Battery pack to the Easy UPS. Refer “Connect the Battery Pack” on page 19 for details.
Low battery cut off. Easy UPS may have discharged the battery due to utility power outage and turned the output off due to low battery condition.	Wait for the utility power to return and charge the battery.
<b>Easy UPS emits an audible beeping sound at long intervals</b>	
The Easy UPS is operating normally when running on battery.	The Easy UPS is operating on battery. See the status of the Easy UPS in the display panel.
<b>Alert LED is illuminated. The Easy UPS displays an alert message and emits a constant beeping sound</b>	
The Easy UPS has detected an internal error.	Refer “Alerts and Notifications” on page 34 for details.
<b>No audible sounds from Easy UPS even when the Alert LED is illuminated</b>	
Audible alert is disabled.	Change the Easy UPS configuration to enable audible alerts.



<b>Problem and/or Possible Cause</b>	<b>Solution</b>
<b>Easy UPS is not providing expected backup time</b>	
The Easy UPS battery is discharged due to a recent power outage.	The batteries require recharging after extended outages. Batteries can wear faster when put into service without proper recharging or when operated at elevated temperatures.
Charger taking more time to charge battery	<ul style="list-style-type: none"> <li>• Be sure that the correct charging current is selected using the charging selector switch.</li> <li>• Input voltage is low to charge the battery with full current.</li> </ul>
The battery is near the end of its service life.	If the battery is near the end of its service life, consider replacing the battery, even if the replace battery indicator is not illuminated.
<b>Easy UPS is not turning off</b>	
POWER OFF button not pressed properly.	Press and hold the POWER OFF button until the beep is heard to power off the Easy UPS.
<b>Easy UPS is in Bypass mode and the LED is not illuminated red</b>	
Easy UPS is configured to stay in the bypass mode.	Change the configuration to exit bypass mode.
<b>Easy UPS is in Bypass mode and the LED is illuminated red</b>	
Easy UPS is in bypass mode even after over temperature alarm is cleared.	Wait for some time for the Easy UPS to come back to online mode.
The Easy UPS has experienced an overload condition and transferred to bypass.	<p>Connected equipment exceeds the maximum capacity as defined in specifications.</p> <p>The alerts remain on until the overload condition is corrected. Disconnect nonessential equipment from the Easy UPS to eliminate the overload condition.</p> <p>The Easy UPS continues to supply power as long as it is in bypass mode and the circuit breaker does not trip. The Easy UPS will not provide battery power in the event of a utility voltage interruption.</p>
Easy UPS detected an internal error and transferred to bypass.	Refer “Alerts and Notifications” on page 34 for details.

# Alerts and Notifications

Easy UPS displays a text code and a numeric code on the display when it detects an internal error.

## Alerts

Display code	Description	Solution
SC	Easy UPS has experienced a short circuit at the output.	Check if there is any short circuit at the Easy UPS output. Remove the short circuit and press POWER ON/OFF button to start the Easy UPS.
OL	Easy UPS is experiencing an overload condition.	Disconnect nonessential equipment from the Easy UPS to eliminate the overload condition. Wait for the Easy UPS to auto-recover.
dCH	The Easy UPS has detected a DC voltage error. Unit will try to auto-recover from this condition.	If the Easy UPS does not recover automatically, contact APC by Schneider Electric.
HOT	Temperature of the unit is rising above the set limits.	Disconnect non-essential equipment from the Easy UPS to reduce the connected load. Ensure that ambient temperature is within limits. Ensure that adequate clearance is maintained.
CH9	Easy UPS has detected a charger error.	Press POWER ON/OFF button to start the Easy UPS. If the error is detected again contact APC by Schneider Electric Customer Support.
Contact APC by Schneider Electric for all other alert codes.		

## Notifications

Display code	Description	Solution
bdc	Battery is not connected.	Connect battery to the Easy UPS. Refer “Connect the Battery Pack” on page 19 for details.

## Service

If the unit requires service, do not return it to the dealer. Follow these steps:

1. Review the *Troubleshooting* section of the manual to eliminate common problems.
2. If the problem persists, contact APC by Schneider Electric Customer Support.
  - a. Note the model number and serial number and the date of purchase. The model and serial numbers are located on the top panel of the unit.
  - b. Call APC by Schneider Electric Customer Support and a technician will attempt to solve the problem over the phone. If this is not possible, the technician will issue a Service Request Number.
  - c. If the unit is under warranty, the repairs are free.

An Authorized Service Representative will visit your location and try to resolve the issue.

## Limited Factory Warranty

Schneider Electric IT Business India Private Ltd. (SEITBIPL), warrants its products to be free from defects in materials and workmanship for a period of two (2) years from the date of purchase. The SEITBIPL obligation under this warranty is limited to repairing or replacing, at its own sole option, any such defective products or parts thereof. Repair or replacement of a defective product or part thereof does not extend the original warranty period.

This warranty applies only to the original purchaser who must have properly registered the product within 10 days of purchase. Products may be registered online at [warranty.apc.com](http://warranty.apc.com) or by mailing in the completed warranty registration card that is included with the documentation.

SEITBIPL shall not be liable under the warranty if its testing and examination disclose that the alleged defect in the product does not exist or was caused by end user or any third person misuse, negligence, improper installation, testing, operation or use of the product contrary to SEITBIPL recommendations or specifications. Further, SEITBIPL shall not be liable for defects resulting from: 1) unauthorized attempts to repair or modify the product, 2) incorrect or inadequate electrical voltage or connection, 3) inappropriate on site operation conditions, 4) Acts of God, 5) exposure to the elements, 6) theft. In no event shall SEITBIPL have any liability under this warranty for any product where the serial number has been altered, defaced, or removed, 7) normal wear resulting from frequent use.

**EXCEPT AS SET FORTH ABOVE, THERE ARE NO WARRANTIES, EXPRESS OR IMPLIED, BY OPERATION OF LAW OR OTHERWISE, APPLICABLE TO PRODUCTS SOLD, SERVICED OR FURNISHED UNDER THIS AGREEMENT OR IN CONNECTION HEREWITH.**

**SEITBIPL DISCLAIMS ALL IMPLIED WARRANTIES OF MERCHANTABILITY, SATISFACTION AND FITNESS FOR A PARTICULAR PURPOSE.**

**SEITBIPL EXPRESS WARRANTIES WILL NOT BE ENLARGED, DIMINISHED, OR AFFECTED BY AND NO OBLIGATION OR LIABILITY WILL ARISE OUT OF, SEITBIPL RENDERING OF TECHNICAL OR OTHER ADVICE OR SERVICE IN CONNECTION WITH THE PRODUCTS.**

**THE FOREGOING WARRANTIES AND REMEDIES ARE EXCLUSIVE AND IN LIEU OF ALL OTHER WARRANTIES AND REMEDIES. THE WARRANTIES SET FORTH ABOVE CONSTITUTE SEITBIPL'S SOLE LIABILITY AND PURCHASER'S EXCLUSIVE REMEDY FOR ANY BREACH OF SUCH WARRANTIES. SEITBIPL WARRANTIES EXTEND ONLY TO ORIGINAL PURCHASER AND ARE NOT EXTENDED TO ANY THIRD PARTIES.**

**IN NO EVENT SHALL SEITBIPL, ITS OFFICERS, DIRECTORS, AFFILIATES OR EMPLOYEES BE LIABLE FOR ANY FORM OF INDIRECT, SPECIAL, CONSEQUENTIAL OR PUNITIVE DAMAGES, ARISING OUT OF THE USE, SERVICE OR INSTALLATION OF THE PRODUCTS, WHETHER SUCH DAMAGES ARISE IN CONTRACT OR TORT, IRRESPECTIVE OF FAULT, NEGLIGENCE OR STRICT LIABILITY OR WHETHER SEITBIPL HAS BEEN ADVISED IN ADVANCE OF THE POSSIBILITY OF SUCH DAMAGES. SPECIFICALLY, SEITBIPL IS NOT LIABLE FOR ANY COSTS, SUCH AS LOST PROFITS OR REVENUE, WHETHER DIRECT OR INDIRECT, LOSS OF EQUIPMENT, LOSS OF USE OF EQUIPMENT, LOSS OF SOFTWARE, LOSS OF DATA, COSTS OF SUBSTITUANTS, CLAIMS BY THIRD PARTIES, OR OTHERWISE.**

To obtain service under warranty you must call customer support. Customers with warranty claims issues may access the SEITBIPL worldwide customer support network through the SEITBIPL Web site: [www.apc.com](http://www.apc.com). Select your country from the country selection drop down menu. Open the Support tab at the top of the web page to obtain information for customer support in your region. Refer to the product user manual for more information on how to contact customer support.

## **APC by Schneider Electric Customer Support**

<b>Internet</b>	<a href="http://www.apc.com/in">http://www.apc.com/in</a>
<b>Toll Free</b>	18001030011/18004194272
<b>E-mail</b>	<a href="mailto:indiainfo@se.com">indiainfo@se.com</a>